

FIRST 2008 GUIDELINES, TIPS, & GOOD PRACTICES

TABLE OF CONTENTS

G	2008 <i>FIRST</i> Guidelines, Tips, & Good Practices	2
G.1	General	2
G.2	Conventions	2
G.3	SAFETY	2
G.3.1	General Shop Safety:	2
G.3.2	Robot-Specific Safety:	3
G.4	Kit of Parts	4
G.5	The Robot - Mechanical	4
G.5.1	General	4
G.5.2	DC Motors.....	5
G.5.3	The Drive Train	7
G.6	Robot Electrical.....	10
G.6.1	Building the Electrical System	11
G.6.2	12V Power System Overview	14
G.6.3	Motor Power Distribution	15
G.6.4	Sensors.....	15
G.6.5	Custom Circuitry	15
G.6.6	Control System	16
G.7	Robot Pneumatics.....	17
G.7.1	Component Definitions	18
G.7.2	Pneumatic Electrical Distribution	19
G.7.3	The Flag Holder	20
G.7.4	One Last Look	20

G 2008 *FIRST* GUIDELINES, TIPS, & GOOD PRACTICES

G.1 GENERAL

The 2008 *FIRST* Guidelines, Tips, and Good Practices section is intended to provide fundamental information, useful thoughts, ideas, and basic direction as you start to design and build a robot. The information provided is consistent with good design practices and standards and, when followed and should yield excellent results for your project. The Guidelines section is intended to be used in conjunction with, but not to be relied on as a substitute for the FRC Rules or any FRC Supplier's specifications or technical documentation.

G.2 CONVENTIONS

Specific methods are used throughout this document to highlight Notes, Cautions, Warnings, key words or phrases to alert the reader to important information designed to help teams in constructing a robot complying with the Rules in a safe and workmanlike manner.

- **Notes**, **Cautions**, and **Warnings** appear in bordered boxes.
- Key words, Phrases, or References (important documents, drawings, etc) appear in bold italics.

Example: ***Always Wear Safety Glasses, 2008 Chassis Kit Manual***, etc.

- Operating keys, controls, buttons appear in bold capital letters.

Example: **OFF/ON** switch, **RESET** button, etc.

We have included references via [hypertext](#). Clicking on Blue Underlined Italic text or graphics will link you to another document containing specific detailed information related to the item or subject being discussed.

G.3 SAFETY

Regardless of whether you are an experienced veteran or “first-year rookie” team, a mentor, or a teacher participating in the *FIRST* Robotic Competition program, it is essential that safety be everyone's foremost concern at all times. *FIRST*, by presenting Industrial Safety awards, continues to celebrate teams that progress beyond the basic practice of safety fundamentals to those who have developed innovative ways to eliminate or protect against hazards,. The winning teams are those that consistently demonstrate excellence in practicing and promoting industrial safety throughout the competitions.

We are listing some important common sense safety fundamentals that need to be followed anytime, but particularly when involved in shop work, hanging around with the robots in the Pits at competitions, or within the vicinity of the competition playing field. This is not a comprehensive list of safety precautions, but a list of good practices to get you started:

G.3.1 General Shop Safety:

- Obey all Safety Regulations as posted in the shop area.
- Always Wear Safety glasses. Eye injuries are the most common hazards in shop environments. Don't become victims; stay safe wearing your glasses.
- Wear proper clothing.

- Avoid wearing loose fitting clothing that could get caught up in shop machinery or by a sprocket & chain apparatus on the robot.
- Safety shoes should always be worn. Wearing sandals, open-toed shoes, or sneakers could be asking for trouble.
- Long hair should be restrained or covered by a cap to avoid any entanglement in machinery or mechanisms.
- Wearing good work gloves can save unnecessary wear and tear on your hands.
- Do not work alone in the shop. Use teamwork. In the event of an accident, immediate assistance should always be available.
- Untrained personnel should not use machinery.
- Keep hands and fingers away from machinery tools while in operation.
- Keep the work area neat and organized. Keep the floor clean of metal debris, oil, or greases.
- Use the proper tool for the job.
- Horseplay is not allowed!

G.3.2 Robot-Specific Safety:

Mechanical

- Use caution when working around the robot. Avoid and eliminate hazards posed by protruding objects and devices, spring-loaded actuators, sharp edges and corners. Where possible, de-burr all holes and sharp edges
- Confirm that all devices restraining mechanically stored energy are either safely secured or fully released before working on the robot.
- Use care whenever lifting and carrying a robot to avoid personal injury such as muscle strains and/or pinched fingers.
- When transporting the robot on carts, rest the robot on blocks and not on the wheels. Use bungee cords or tie downs to restrain the robot on the cart.

Electrical

- Shut the Power OFF before working on electrical circuits or exchanging components. Open the Main Circuit Breaker with the RESET button and/or unplug the battery.
- Remember to always verify the correct polarity when connecting devices. Some components may not be clearly marked. Always confirm the correct polarity from the manufacturer's manuals.
- Following electrical service work always inspect, test as necessary, and clear potential short circuits before applying power.
- Protect electrical circuits and wiring from accidental contact by persons and from contact with metallic foreign objects. Cover these areas with clear acrylic plastic panels where necessary.
- Routinely inspect batteries for cracked or damaged battery cases, or any evidence of electrolyte leakage, etc. Avoid contact with the battery chemicals and follow proper procedures for the handling and disposing of hazardous materials.

- Always use the recommended battery charger to prevent overcharging and potential damage to your battery. Old or defective batteries must be safely discarded as specified for the disposal of hazardous materials.

Pneumatic

- Respect stored pneumatic energy. Do not aim or direct high-pressure air at co-workers as a joke. Serious injury could be an unintentional result.
- Before servicing pneumatic components, confirm that the Main Vent valve is fully open. Inspect all pressure gauges to verify that NO pressure is present.
- Stay clear of any cylinders and mechanical attachments when the air system is charged; particularly keep clear when setting a cylinder in motion.

G.4 KIT OF PARTS

The **FIRST 2008 Kit of Parts - Section 10** (of the FIRST Robotics Competition manual) is the source for useful information concerning the kit contents for 2008 and “Who to Contact” for obtaining any replacements for any missing items from the kit. In addition, Section 10 provides contact information and the process to purchase extra kit materials and replacement part. A description of the FRC loan policy, procedure, and requirements for borrowing Control System components at competitions whenever necessary is included.

In this document we call attention to various parts and particularly to some of the new items found in the kit. Collectively, they can add some useful features and capability to your robot for this year’s competition. At the end of this document, teams can find a “Where to Buy” list to aid in shopping for additional KOP items.

For specific product or kit parts information, we encourage teams to explore the FIRST web site at http://www.usfirst.org/robotics/doc_updt.htm, and the Innovation First web site <http://www.ifirobotics.com/> to download essential parts documents and specifications of interest. Many of these documents are available to you on these sites.

G.5 THE ROBOT - MECHANICAL

G.5.1 General

This year it is most likely that teams will continue to design and build robots in a variety of forms to perform the games strategic functions. Many robots will be speedy and highly maneuverable. Other designs might focus on strength and control, or altering configuration to gain advantage. Most designs will be very capable of withstanding vigorous interaction with other robots. The end product for each team customarily will be the result of brainstorming and building to a unique game strategy and a plan beneficial to an alliance. Along the way, here are a few important design concepts to keep in mind.

- **Remember thy Robot Weight Limit**- All of the elements of the robot such as the drive system, frame, electrical system, pneumatics, and all other mechanisms share a portion of the robot’s overall total weight. In particular, *this year all teams need to verify the robot weight restrictions that are applicable to the robot design as stated in Section 8 of the FRC Manual.*

In every case, the best strategy is to set up a “weight” budget plan for each element or segment of your robot (such as 25% drive train, 15% electrical, 15% pneumatic, etc). Then stay within the weight budget throughout the build cycle. At the end of the project you just might have some allowance to add a bit more weight to enhance a robot system or two as needed and avoid wasting time performing a “panicky” weight reduction process at your first Regional inspection.

- **Keep it Simple** – The more complicated the robot design, the more likely something will go wrong. Focus on strengthening the weakest points of your design for best reliability.

- **Build it Right**– Consider certain basic principles such as keeping the mass weight of the robot as low as possible for best maneuverability and stability. Plan to locate all delicate devices, circuitry, and sensors inboard of the framework and under cover for best protection.
- **Change is good** – A sign of progress as you go along building the robot is that you will find modifications and adjustments are necessary. It might mean relocating transmissions, moving electrical components, or reinforcing structures. It may include adding materials to repair or enhance a mechanism. Always keep in mind to control your weight budget and implement any changes accordingly.
- **It's Gotta Go in the Crate** – Remember that at the end of the project the robot has to fit inside a shipping crate (please refer to Section 4 for details). The height limit includes the 4-inch base supports required on the bottom of the crate as well as the thickness and height of any framing lumber on the top edges of the crate.

So, plan ahead... The (probable) headroom space inside the crate will limit the shipping height of the robot to roughly about 5' 2". Also, beware of the maximum crate weight before "excess shipping tariffs" kick in. See the **Transportation, Section 4** of the FRC manual for complete crate specifications and shipping requirements.

G.5.2 DC Motors

Selecting an appropriate motor to perform a specific function such as turning a wheel, lifting an arm, or squeezing claws is an important part of the design process. Motors that may be used in the 2008 FRC competition are those permitted by the 2008 FRC Rules found in Section 8 of the FRC manual. The 2008 kit motors are listed in the table below.

Although some choices are obvious, before you begin to make motor selections, you should have determined a few pieces of information. First, know what type of robot you intend to build. Must it be fast and maneuverable, or methodical and precise? Factors such as moments of inertia, friction characteristics of the load, and power needs are relevant. Perusing the different motor properties such as RPM, torque, speed, power, and weight will help you to focus on those most important factors to facilitate your design

Each motor has a unique set of speed/torque characteristics that can be adapted to perform work by the robot. Some are quite powerful and draw high currents when loaded to their limits. Others have very high-speed capability. Some include gearboxes that define their gear reduction, output shaft speed, and torque output. The table provides the peak power rating, torque and current at "stall", and the "no load" speed and current for the kit motors typically based on the voltage input of 12VDC.

The Kit motor specifications normally provide torque/speed characteristics in tabular and/or graphical forms. The torque/speed curves for most motors are depicted as linear from max to min ranges and these curves can provide a good deal of information about the motor.

In the graphic shown here, a torque curve (black line) of the CIM motor rises from "0" torque along the "X" axis to about 343.4 Oz-in torque at "stall". The motor "speed" curve (green line) on the "Y" axis reaches a maximum RPM of 5310 at "0" torque (no load)

CIM MOTOR TORQUE/SPEED CURVE DATA

TYPICAL PERFORMANCE @ 12Vdc	Torque	Speed	Current	Power	Effcy
	Oz-In	RPM +/- 10%	Amps MAX	Wo	%
Free Load	0	5310	2.7	0	0%
Normal Load	64.0	4320	27	205	63%
@ Max Efficiency	45.0	4614	19.8	154	65%
@ Max Power	171.7	2655	67.9	337	41%
@ Stall	343.4	0	133.0	0	0%

HIPOT: 600 Vac/0.5 mA/1 sec
Insulation Resistance 10 M Ω
Insulation Class B

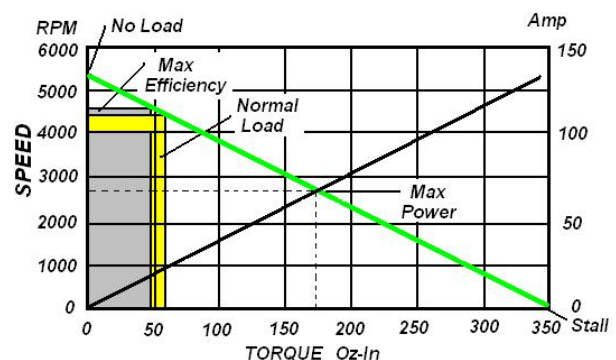

with the motor current about 2.7 Amps. However, torque and speed are inversely proportional. As torque (load) increases, the speed drops toward “0” or toward the “stall” condition while the motor current rises and will peak around 133 amps at the “stall” condition.

The point where the two curves intersect is the measure of “Maximum power”; where speed, peak power, and torque for this motor are optimized. For any motor this point becomes the truest measure of a motor's power, taking into account the torque and speed character of the motor.

The yellow box indicates a suggested normal load range (as determined by the manufacturer) for this motor at a torque output up to 64 oz-inches, a current of about 27 amps, and a speed up to 4350 RPM. Teams will ultimately determine their own normal operating range, based on their robot requirements. Perhaps altering the gear ratio to trade-off higher power consumption, with a little less speed to gain more torque will be very important in the design.

As you can see by the graphic, at the Max Power point, a typical CIM motor would operate at a speed around 2800 to 3000 RPM at its output shaft. Obviously this is too fast to connect directly to the wheels. Besides, the available torque at those speeds is pretty small. Typically some gear reduction (around 12:1) with a transmission and sprockets will bring speed down to around 230 to 250 RPM and increase available torque. The benefits are gaining starting power, getting the top speed down to something that can be controlled, and increasing the pushing power and maneuverability of the robot.



The torque/speed data presented here is based on a single voltage level (12V). In actual operation the motor speed/torque will shift toward the origin as the voltage applied to a motor is reduced because of joystick setting or by the decreasing battery voltage. A low battery produces lower current, speed and torque. Conversely, higher voltage yields higher torque and speed delivering higher current and allows more heating of the motors.

Most of the motors supplied in the Kit were not originally designed to drive robots. For example, the motor shafts on the Globe and Mabuchi motors are designed to provide axial torque only, and drive secondary shafts or mechanisms. They do not like significant transverse or side loads imposed on their motor shafts. When using these motors, always take care to securely fasten the motors to a proper gearbox or couple the output shafts via flexible couplings to the business side of a drive train when used for motive power (as suggested in this graphic).

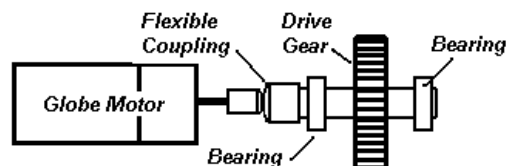

Selecting appropriate ratios for gears, sprockets, chains, etc. to perform within a motor's power band is the goal. Poor motor performance or premature failure may occur if the transmission ratios employed are not properly chosen to allow motors to operate within their preferred or “normal” torque/speed/current ranges. Using kit supplied gearboxes and sprockets will make these choices easier for you. In some cases, gear change kits, adapters, and/or sprockets may help you fine-tune a motor to better suite your application.

Motor Bias

Teams should be aware that certain motors have a built-in bias toward rotating in a preferred direction. This bias, a result of brush timing, will cause the motor to produce slightly more torque and turn a bit faster in one direction. In the reverse direction of rotation, the same motor will run a bit slower while producing less torque. For example, a pair of CIM motors might exhibit timing bias symptoms as follows: When the robot is steered forward one motor rotates in the clockwise direction while the companion CIM motor is rotating counter-clockwise. With pronounced bias, any speed difference between the motors will cause the robot to drive off the

intended straight track to one side. Generally CIM motors are fairly well balanced, but should you encounter this symptom you may need to compensate for the difference.

So, be cautious and consider most torque/speed curves as valid only for the primary direction of rotation. If balanced performance will be critical to your design, torque/speed measurements of motors should be checked in both directions.

Note in the table above that CIM motors are very capable of drawing in excess of 100 Amps at stall. Operating these motors near the Max power point for more than a few seconds will likely trip the auto-resetting 40 Amp circuit breaker and result in losing drive control of the robot until the circuit breaker cools sufficiently. The breaker will eventually reset, and the motor will resume operation. In competition, its far better to limit or avoid this situation and in your design select gear ratios that will keep the motor current operating within the safe range of the current protection offered by the circuit breakers.

Special Notes on Motors

CIM motors - The 2008 Kit of Parts provides two FR801-001 CIM Motors. The kit also includes 1 - FP801-005 Mini-bike motor. The Parts kit also includes a pair of NEW 12:1 56mm planetary gearboxes supplied by BaneBots. These assemblies readily accept mounting of FR801-001 CIM motors supplied in the kit. Section G.5.4.1 describes a procedure to fit the motor onto the gearbox.

Denso Window Motors- These motor/gearbox assemblies have an automotive quick-connect electrical connection, which is a Packard type (P/N 12129487). The Packard mating connector part number is 12129486. This item is not provided in the kit. While having a genuine mating electrical connector is ideal, an alternate connection method for this motor would be to use a pair of 14-16 gauge female insulated Slip-on (Quick Disconnect) terminals such as Terminal Supply part BB-8135 or Stakon's RB14-110F terminals. These terminals fit posts 110 x .032 in. and will make a firm and reliable connection for the motor.

You will also find a 9-toothed plastic coupler supplied by Pelham Plastics which mates the Denso motor output gear to either a 5/8" keyed shaft or, by the flange coupling, to a drive plate.

Keyang window motors - There are two Keyang window motors in the 2008 KoP, PNs 16627960 or 61 and 16631023. The 16627960 (or 61) has an automotive quick-connect 2-piece electrical connector supplied in the KoP.

The kit includes couplers that mate the output gears of the Keyang window motors to drive various mechanisms.

G.5.3 The Drive Train

The Mechanical Drive Train consists of those components that connect the drive motors to the wheels or tracks of the robot.

Some general advice if you plan to build up an alternate robot drive system from scratch is offered below:

- If designing an axle-based drive train, assure that the weight of the robot is fully supported by the axles and shafts of the transmission or gearbox, and not by the drive shaft of a motor. Use bearings and bushings on the axles and shafts to provide proper support and minimize friction. Remember, the greater the robot weight, the more internal friction the drive train components will experience. Align mechanical power transmission components accurately.
- If you couple a motor shaft to another shaft assure that the coupled shaft is supported with bearings at two points as shown previously. Use flexible couplings to connect the motor shaft to the shaft.
- Incorporate sufficient gear reduction in your drive train to provide ample drive torque for the desired robot speed.

Bearing Insertion

Inserting a pair of bearings into each side of the wheel hub is normally a simple operation, particularly if an Arbor Press is available in the shop. The wheel hub has a slight recess at the opening of the bearing cup and this recess helps to set the bearing in a true orientation for insertion.

- Center the wheel and bearing under the press face. Apply moderate light pressure on bearing face to start driving the bearing down into its recessed position.
- Check that the press surface applies equal force across the entire bearing face and not just on the inner race of the bearing. Also check that the bearing is uniformly being driven into the hub. If the bearing is not properly aligned, the bearing and/or the wheel hub could be damaged.

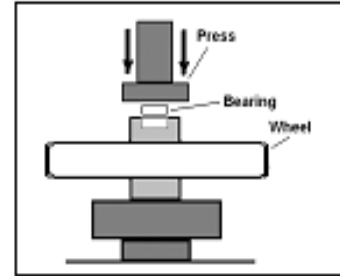

The bearings could also be more crudely inserted by using a soft-headed hammer or rubber mallet. Lay an intermediate flat surface such as a small metal plate over the bearing and tamp on the plate to seat the bearing. After both bearings have been installed in all four wheels, the 24-toothed drive sprockets can be screwed or bolted onto the hub assembly of the drive wheels using appropriate hardware.

Note that these R8 bearings have open races. The bearings are lightly oiled. Once installed, the bearings should be coated “lightly” with bearing grease. Teams are also advised to periodically check the wheel bearings, clean and re-lube as necessary.

Adding Sprockets

A pair of 24-tooth sprockets is provided in the Drive Train bag to drive a basic 2WD system. A 4WD system requires that each wheel be driven and all wheels must be fitted with a 24-tooth drive sprocket. In this case, two more sprockets must be ordered.

Each wheel hub has 6 holes that could be drilled through using a 3/16” bit. Then insert 6 ea. #10-32 x 1.75” Round or Button head SS machine screws through the sprocket and mating hub holes. Or, the hub holes could be tapped with a 10-32 tap to accept # 10-32 x 1.5” (ea.) Socket Cap screws. The figure shows examples of “drilled through” and “tapped” hardware.

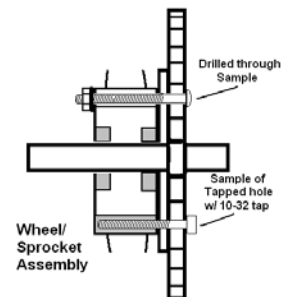

Finish by installing the lock washer and nut hardware and tightening onto the screws. Once the sprockets are in place, the wheels will now be ready for mounting onto the chassis frame.

Wheel Placement

When using the Chassis kit typical frame design, a 5” long 1/2” Hex Head Cap bolt could serve as a cost-effective and satisfactory axle. The holes in the chassis rail must be enlarged from 3/8” to 1/2” to accommodate the larger bolt required.

Alternately, a 5” long 3/8” Hex Head Cap bolt may also serve as a cost-effective and satisfactory axle. Additional spacers, sleeves, and washers should be used to take up the free space between the bolt and wheel bearings and to keep the wheel in a semi-fixed position on the axle. The wheels should wind up being more or less centered in the wheel channel. The exact placement is determined by the position of the drive sprocket on the transmission output shaft.

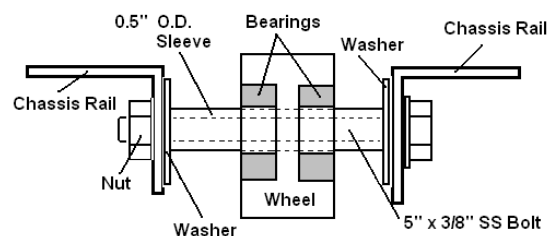

WHEEL MOUNTING IDEA

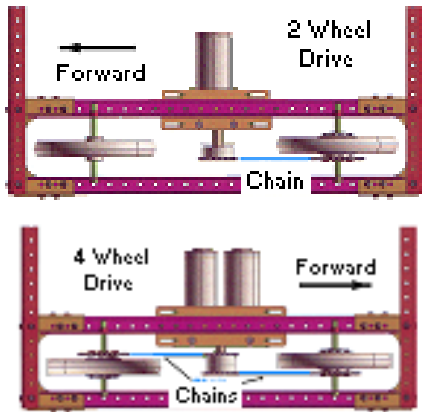

Depending on the robot design, 2WD may call for the driven wheels to be mounted at the rear of the chassis or mounted forward. The left-side wheel arrangement opposes the right side in that the sprockets will face outward on the rear wheels. The wheels can be positioned forward or backward from the locations shown in the drawing and that placement will impact the maneuvering and stability of the robot platform. There is adjustment available in the wheel channel to accommodate changes gleaned from driving tests & evaluation.

In a 4WD system each wheel is equipped with a sprocket. However, the wheels in each channel need be installed so the inner wheel sprocket will mate up with the inner drive sprocket on the transmission shaft and the outer sprocket can mate up with its outer sprocket. For 4WD, the left-side wheel channel arrangement mirrors the right side. For example, in the picture the right forward socket is facing the outside. On the left side of this frame the forward sprocket will face the inside. The drive wheel sprockets can then be connected to the individual transmission sprockets via chain when the transmissions are mounted.

Mounting the Chain

The KOP includes a 10-foot length of ANSI #35 chain and a pair of master links. #35 chain is selected because it can handle abuse appropriate for robotic needs without being too heavy. Chore #1 will be to determine the length of chain you will need between sprockets. Chore #2 is to break the existing chain at the necessary length with a chain breaker tool. Finally, chore #3 will be to join the chain back together with a master link. The number of chains you will need depends on whether the robot will be a 2WD, 4WD, or perhaps even a 6WD robot.

Now that you have the frame, with a pair of transmissions mounted on the frame and a set of wheels mounted as shown in the figures above, you will need to size, break, and join two clean ends of the chain with a master link. When you size the chain, select a particular link & pin that will produce a “clean link” (end with an open internal hole). The length should result in the chain being slightly longer. That’s better than ending up with a chain that’s too short.

The tool you’ll need is a “Chain Breaker”. This tool is designed to slip over and grip the links on the chain by squeezing the handles as shown.

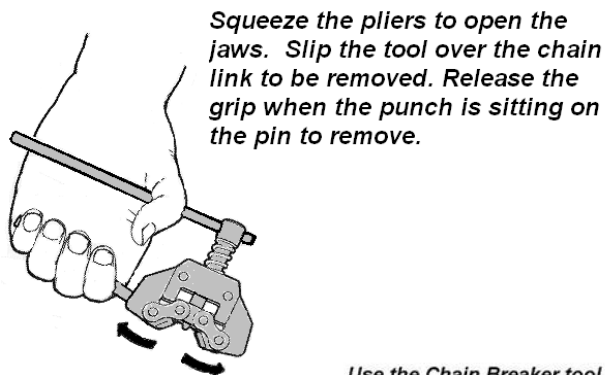

The tool “punch tip” should be positioned directly over the pin to be removed. When the punch is sitting squarely on the pin, turn the upper handle “cw” to start driving the pin down through the link plate. When the pin is about even with the plate surface, move the tool to the second pin and drive it down into the plate about half way. Finish by driving pin 1 through the link plate and then drive pin 2 through the plate.

Now that the chain is broken to the correct length all that remains is to rejoin the chain on the sprockets with a master link. The master link (in the drive train bag) is the

Use the Chain Breaker tool to push the pins down, forcing the link out of the chain.

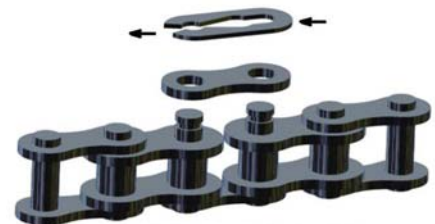
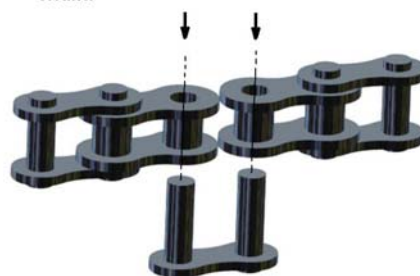

1. Slide the Master link pins fully into the chain.
2. Add the side plate.
3. Set the spring clip over the pins and use pliers to lock on to the pins.

reusable link that uses a side plate and spring clip to hold the chain together.

- 1) Wrap the chain onto the sprockets such that the clean links are supported on the sprocket.
- 2) Slide the master link fully through both pinholes.
- 3) Add the side plate over the master link pins.
- 4) Place the spring clip (as shown) over the pins with open end of the clip touching the second pin. With pliers, squeeze the end of the clip using the pin as a lever and guide the open end of the clip around the second pin.

Here are a couple of points to check as you are connecting chains:

- **Alignment:** Be sure that the wheel sprockets and gearbox sprockets are properly aligned with each other. Verify the sprockets are in the same plane with the chain attached. The chain must not be cocked at any angle, but will always leave the sprocket gearing in a straight path toward the mating sprocket as the wheel is rotated in either direction.”

- **Chain Tension:** Check the chain tension. If the chain is too loose or sloppy, it could result in poor response to direction changing and in the worst case, could start jumping teeth on the sprocket resulting in lost drive. The rule of thumb for slack is about 3% of run length (distance between sprocket centers). Typically +/- 0.5”.

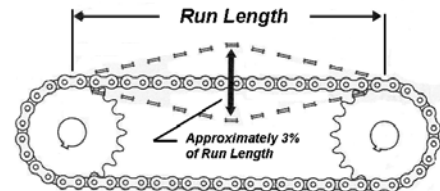

DETERMINING CHAIN SLACK

- Whenever two chains drive a pair of wheels or four chains drive four wheels, it is especially important to assure the chain tension is nearly identical for all drives.
- **“Stretch”:** New chains will “stretch” after installation and it is most likely that some slack will need to be eventually removed. However, if the chain is set too tight at this point of assembly, keep in mind that when the full weight of the robot structure is applied, the transmission components and the drive train will likely be subjected to extreme friction with a serious reduction in drive efficiency. The “ ideal” chain tension initially is that point where the chain will not slip.

G.6 ROBOT ELECTRICAL

The Electrical System is the primary source of energy for the robot. The system includes the 12V battery, the electrical devices and the network of wires that distribute the electrical energy to the motors, to the pneumatic actuators, and to the Robot Controller and sensors. The block drawing illustrates the basic electrical energy supply relationship between the Main Power system, the Mechanics & Drive systems, Pneumatics system, and the Robot Controller.

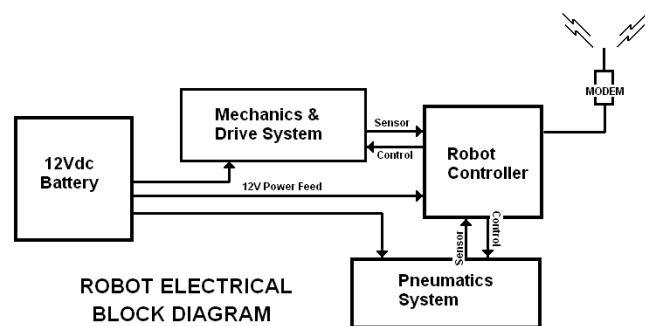

One can see that getting full electrical energy from the battery supplied to each system is important to the robots total performance. Thus, it seems appropriate to begin this electrical system discussion by first focusing on the electrical network and the means to provide the necessary power to do the work.

G.6.1 Building the Electrical System

Wire & Wire Size

For those not familiar with electrical standards, all wires are classified by the American Wire Gauge system, and are assigned “gauge” numbers according to the wire’s cross-sectional area. The table shows standards for the AWG gauge number including: the diameter in inches and millimeters, the wire resistance per 1000 feet, and a maximum rated current for the wire gauge at 12Vdc input.

Note the higher the AWG number, the smaller the wire size. For example, a #20 AWG wire has a diameter of 0.0369 inches. A #12 AWG wire has a diameter of 0.0933 inches.

Two additional columns show the wire resistance for a 6-foot length of the cable and the voltage drop in that section of cable when a 100A current flow is applied through the wire. The maximum current rating is based on a 2.5% voltage drop.

FIRST Robot Rules specify the minimum allowed wires AWG sizes that may be used to supply the robot’s electrical loads. Remembering that choosing the wire size (AWG) can be important toward delivery of full power to a load while protecting the wiring integrity, teams may opt to use somewhat larger gauge wiring (smaller AWG number) to compensate.

Polarity and Current Paths

In addition to being electrically isolated from each other, all positive and negative wiring **must** be isolated from the robot’s chassis. Teams must ensure that no electrical devices or custom circuitry on their robot are electrically common with the chassis (no “grounded” housings). **The negative terminal of the battery must not be connected to the robot chassis.** Teams must reference Section 8 when wiring their robot.

Cable Routing & Harnessing

FIRST recommends all teams take the time to follow good cable routing & harnessing practices and that all wiring be laid out in a logical, orderly manner between circuit devices.

- Whenever possible, harnesses should be sorted and separated into “power” and “PWM/sensor” cable groups. Ideally they should be run in different pathways to their destinations. Minimizing interference between wires could become an important factor to the robot’s reliable performance. In addition, “grouping” can be a useful aid in troubleshooting and servicing the robot. Choose a safe and protected pathway inboard of the main robot frame for the harness, to ensure the robustness and reliability of the electrical system.
- Wires leaving devices should be grouped and bound together with plastic ties to form wire harnesses. Binding the wire bundles together using plastic tubing or quick ties and chassis anchors provides firm support for wires in rugged environments.
- Wires and groups of wires, passing through chassis holes or around cutouts with sharp edges, need to be protected, usually by a plastic sleeve, plastic tubing, plastic helical wire wrap, or by rubber grommets against chaffing.

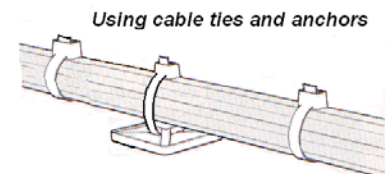

**AWG STRANDED WIRE
Resistance & Voltage Drop Table**

AWG	Size		Resistance ohm/1000'	6 feet Resistance (Ohms)	Voltage Drop (Volts)	Maximum Current Capacity
	Diameter inch					
20	0.0369		10.360	0.0622	6.22	5 A
18	0.0465		6.520	0.0391	3.91	7 A
16	0.0587		4.080	0.0245	2.45	12 A
14	0.0740		2.580	0.0155	1.55	20 A
12	0.0933		1.620	0.0097	0.97	30 A
10	0.1177		1.020	0.0061	0.61	50 A
8	0.1484		0.640	0.0038	0.38	80 A
6	0.1871		0.402	0.0024	0.24	125 A
4	0.2360		0.253	0.0015	0.15	200 A

*Calculation shown for 6 feet of wire @ 100 Amps @ 12Vdc
Max Current rating based on allowable 2.5% voltage drop*

Wire Terminations

As you build the robot, keep in mind that any connected wire terminal or plug may need to be disconnected for service on occasion. It's normally a good idea to provide a small amount of slack in the wire to permit detachment from terminals. However, leaving excess slack should be avoided. Not only can it be messy, but loose wires might get pinched, grabbed, and torn away by intruding robots at the most inconvenient times! Use good judgment, both in routing, securing harnesses, and terminating wiring.

Terminations

One key towards getting full power delivered to load circuits in the robot's construction is in fabricating good terminal connections. This may sound simple, but to maintain electrical integrity, tensile strength and insulation properties, sound-crimping techniques must be used.

The drawing gives an example of a typical robot electrical circuit. The "R" components represent the resistances added to the circuit from each terminal connection. Ideally, these would be always be "0" ohms. However, one bad crimp or poor solder job could insert unwanted "ohms" into a circuit, resulting in a significant voltage drop, and lost power.

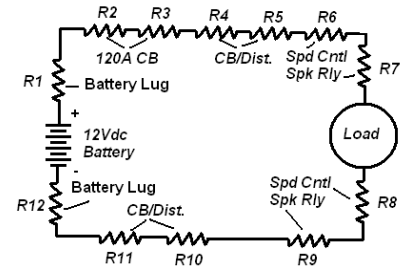

TYPICAL WIRING CIRCUIT RESISTANCES DUE TO TERMINAL CONNECTIONS

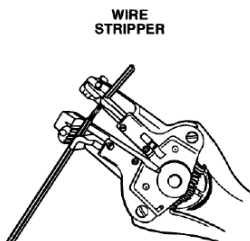

A good crimp relies on the preparation of the wire, the terminal type, and the quality and use of the crimping tool. If any of these items are out of specification, an unacceptable crimp may result. The general rule is to strip the outer insulation from the wire using a wire stripper tool with cutting slots matching the wire gauge size. The insulation should be stripped (approximately 1/4") so that, when fully seated in the terminal lug, the ends of the wire strands just protrude through the barrel.

Slide the terminal lug over the wire strands so that all strands are fully into the terminal sleeve and the wire insulation is under the insulating sleeve of the lug and just butting up to the inside sleeve inside the terminal barrel. The wire insulation must be fully seated inside the lug insulation sleeve for proper support. You should now see the tips of the copper strands just protruding through the barrel.

When using the kit crimping tool use the "insulated crimp" area of the tool as shown in the figure. Center the lug barrel on the proper die on the tool approximately at the 1/3-point closest to the stud end of the lug. Apply firm grip pressure. More pressure is usually needed for larger wires. Test the crimp by holding the terminal and tugging on the wire. The lug should not pull off.

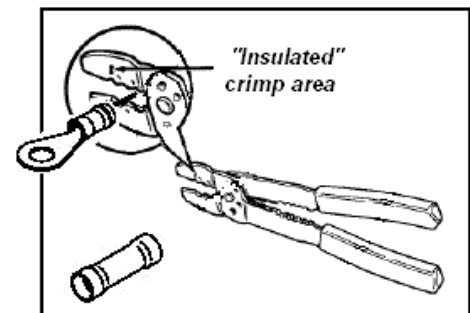

- Over-crimping by using excessive pressure distorts the integrity of the wire strands and weakens the binding strength. Eventually the resistance of the joint will increase due to heating and chemical interaction and an unreliable connection may result.
- Careless positioning of the lug and wire in the crimping tool may result in a partial clamp of the wire at the tip, or a clamp on the wire insulation and not the conductors at the end of the barrel. Take your time and get it right. This is very important!

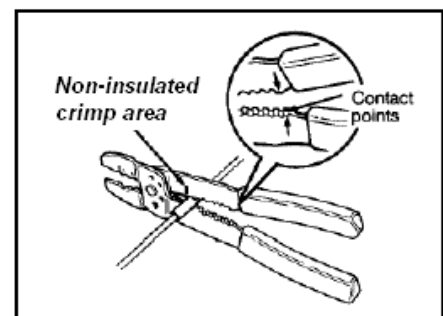

Crimp-on connectors that are improperly crimped may work at first, but can fail easily due to the operating vibration of a robot. Crimps fail if you push the wire so far into the terminal that

when the crimp is made, it is only binding on the wire insulation and not on the wire strands. If the crimp is made with insufficient pressure, the wire will pull out easily. The real test is doing an ohmmeter continuity test on the lowest (R x 1) scale. Verify “0” ohms resistance from end to end of the conductor.

Solder-less terminal manufacturers consider that the highest levels of reliability are achieved using solder-less terminations. The SAE, (Society of Automotive Engineers) specifications highly recommend that all terminal lugs attached to 10AWG or larger wire should be first be lightly crimped on to the wire and then soldered. This requires some knowledge and skill about applying solder and making quality solder connections.

If you choose to follow this recommendation, you will need a soldering gun or iron of at least 45 watts for soldering larger lugs and wires and a roll of rosin-core solder. The rosin core cleans the wires and prevents oxidation as it binds the wires in a flow of solder.

You should strip the insulation from the wire as before, so that, when fully seated in the terminal, the ends of the wire strands just protrude through the barrel. Then pre-tin the bared wire strands with a melted flow solder, assuring a good clear solder flow (silvery color). Slide the lug onto the wire and crimp the lug lightly with the crimping tool using the appropriate lug size crimp hole.

Then re-apply the tip of the soldering iron onto the junction of the wire protruding at the lug barrel and the lug barrel. Heat this junction, and using a strand of solder, flow melted solder into the junction observing the flow of shiny metal solder. Remove the soldering iron and hold the wire still to let the junction cool. The junction should remain metallic in appearance and not turn to a chalky white/gray in color.

Splicing Wires

Although you never want splices, it may be necessary at some point to temporarily extend a wire for a connection. An assortment of insulated or non-insulated butt connectors is available to make this job easier and more reliable. This drawing shows an example of a non-insulated butt connector being used to join two

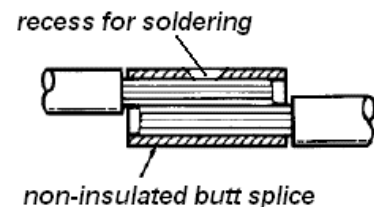

conductors. This type of splice is normally “crimped and soldered”. The junction should then be wrapped with electrical tape and covered with a length of shrink tubing for protection. Insulated butt splice terminals are frequently just crimped using the procedure described in the Wire Terminations paragraph above.

Labeling

When possible, take the time to label wires and devices. It will save time later when modifying, troubleshooting, replacing components, and reconnecting wiring. Labeling can be done with heat shrink tubing or white electrical tape and a fine point permanent marker. If time permits, create a robot-specific wiring diagram for reference. The diagram and wire labeling will make it easier to trace and interpret circuitry during technical inspection and whenever resolving electrical problems.

Inspection

Be sure to inspect your robot’s systems on a frequent basis following service work or when participating in an FRC event. Detecting and repairing minor damage to harnesses, individual wiring, or connections may prevent a future failure that could harm the power or control system or cause a robot to stop dead in the middle of a match.

WARNING

Please read the following sections very carefully. Failure to wire the robot properly could damage the control system and invalidate the control system warranty. *FIRST* and/or Innovation First will not provide free replacement of components damaged due to misuse or improper wiring. Teams will be required to correct wiring that is not configured according to the **2008 Robot Power Distribution Diagram** and according to the Control System rules in the Robot Rules section before being allowed to compete

G.6.2 12V Power System Overview

The 12V Power system consists of the 12Vdc battery, 120 Amp Main Circuit Breaker, DIN Power Distribution block, and the Circuit Breaker/Distribution panels. In all cases, please refer to the Section 8 of the manual for specific guidance to wire the electrical system of the robot.

Locating System Components

When planning the layout and location of robot hardware and systems, priority placements should be given to the 12V Power system components as follows:

The 12Vdc Battery **must** be:

- Accessible for easy replacement and/or recharging and inspection. If, in the heat of competition and with a short time interval between matches you need to swap out batteries, having easy access will be worth its weight in gold.
- Firmly mounted but protected from contact by either the robot's own mechanical hardware or by other robots or field hardware. Batteries can be severely damaged if impacted and/or shorted by another robot.
- Be located as close as possible to the 120A Main Circuit Breaker, and to the Power Distribution DIN block to keep wire lead lengths as short as possible.

The 120-Amp Circuit Breaker *must be located*:

- Near the battery
- *In an accessible, protected area.*

Power Distribution DIN Block should be located nearby the 120-Amp Circuit Breaker to minimize the length of power wiring.

ATC circuit breaker/distribution panels placement for the best position to accept the incoming wiring from the distribution block and to route output wiring to loads. It also helps to have accessibility, protection, and convenience to service the panels whenever necessary.

12VDC System Assembly

FIRST supplies 4 Red Anderson Power Connector assemblies (red tote); one pair to connect the 12V battery to the rest of the Power Distribution system, the others are intended for the spare batteries. The Anderson connector provides a means of quick disconnect and exchange of the battery on the robot whenever necessary. In the Terminal Bag, lugs are provided to mate the #6 AWG cable to the battery posts.

The (Red) wire on the Input side of the Anderson connector must be connected directly to the Positive post of the ES17-12 battery. Tighten bolt. Finish by fully insulating the post with electrical tape. The Negative (Black) # 6 AWG wire must be connected to the Negative post on the battery. Tighten the bolt. Finish by fully insulating the post with electrical tape.

Plasti-grip Ring terminals (1/4" 6AWG) are used to connect the opposite half of the Anderson connector cable to the Main 120 Amp Circuit Breaker BAT post and from the AUX post to the DIN Block.

WARNING!

Make a final re-check that the Red wire is on the (+) post and Black on the (-) post. Improper polarity can damage CONTROL SYSTEM components.

G.6.3 Motor Power Distribution

Refer to the **2008 Robot Power Distribution diagram** to review the 12Vdc power cabling interconnections between the CB/Distribution panels and the V884 speed controllers or spike relays for various motors.

The sections that follow provide some practical guidelines, recommendations, and cautions regarding these interconnections. You will always find the specific wiring, programming, and operating details in the manuals for the various actuators available at the Innovation First web site at <http://www.innovationfirst.com>.

G.6.4 Sensors

In general, the robot controller anticipates receiving inputs from sensors either in the form of contact closures (digital) such as those from a gear tooth sensor, or as 0-5V voltage levels (analog) at its input ports. In the case of analog signals, the robot controller supplies 5Vdc at 1 Amp for the analog inputs. As there are 16 input possibilities, each port should be limited to approximately 50ma. The input types, a combination of potentiometers, accelerometers, and gyro (yaw) rate sensors, should present high impedance to the analog input. All potentiometers are recommended to be 250 ohms to 100kohms. For information about the sensors in the kit, please refer to the **2008 Sensors Manual** on the *FIRST* website.

Typical wiring configurations for various analog sensors, switches and other devices to the analog or digital input terminals on the robot controller should conform to the Pin out and software function schedules included in the Innovation First, Inc. Robot Controller Reference Guide at: <http://www.innovationfirst.com>.

WARNING

Do not connect switches to the +5v Output Pins of the robot controller. The +5v output pins are intended to supply a fused 5Vdc AUX power for use by analog sensors.

Do not connect any other voltage to the analog inputs on the robot controller. It may damage the device.

This year's Kit of Parts provides an interesting assortment of sensors and software tools to help teams develop a very competitive robot. In particular, the game relies on advanced robot control.

G.6.5 Custom Circuitry

It is not possible for *FIRST* to test all custom circuits other than as specified in the Rules. So, we rely on all teams to use Gracious Professionalism (and good engineering) when building and implementing custom circuits in their design.

Please read the *Control System* documentation from Innovation First for information on the robot controller sensor inputs. Support by *FIRST* and Innovation First for additional electronics and custom circuits is limited to the documentation provided in your kit and that which may be found on the Innovation First website.

G.6.6 Control System

Please refer to the Innovation First, Inc. documentation for use and programming for the 2008 control system, www.ifrobotics.com.

“Stuck” Robot Controllers

Once in a great while a team may see the following symptom, which appears as if their full-size robot controller is "stuck" following a USER program download.

Cause: The problem appears to occur when a PC corrupts the serial port timing. USB-serial converters are more susceptible. If this problem continues to re-occur, try downloading the User code from another PC.

Identifying the Problem: The "Battery Power" LED blinks green, the "Program State" LED is solid yellow, and all others are dark. Resetting the RC does not clear it. Code will download, but it will not run. Your RC will not link to an OI.

Solution: Follow the procedure below with power applied to reset the RC unit from this “stuck” state:

1. Press and hold the **RESET** and **PROG** buttons at the same time.
2. Release **RESET**; continue to hold **PROG** until the "Battery Power" light becomes a solid green.
3. Release **PROG**.
4. Hit **RESET**.

You should be operational again and able to link with an OI. You may now download new User code if required.

Caution

Connect switches between a Digital I/O Signal and Ground. Do not use lighted switches with the Operator Interface unless the switch light circuit is disabled.

Warning!

Do not connect switches to the +5Vdc fused Aux Pin (Pin 1) of the Input ports of the Operator Interface. It may damage the switches. Pin 1 is intended to supply fused 5Vdc power for use by analog sensors and potentiometers.

Any analog sensor must be connected to +5 Vdc Aux, Ground, and an analog input. Potentiometers must be connected to +5 Vdc Aux and an analog input. All potentiometers should be 100KΩ. Due to the special nature of the analog inputs on the Operator Interface, connecting potentiometers to Ground is optional but *not required*. See the Innovation First documentation for more information.

Figure 5.3 shows an example of the proper way to connect a switch, potentiometer, LED, and yaw rate sensor to the **Operator Interface**. Port and Pin designations shown in Figure 5.3 are merely examples and will vary depending on the number of devices connected.

Potentiometer

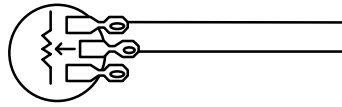

Port 3

Pin 1 (+5 Vdc)
Pin 3 (Port 3 X-Axis)

Rocker Switch (Typical)

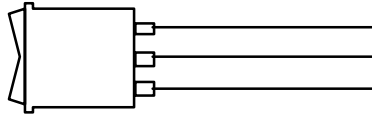

Pin 10 (Port 3 Aux Switch Input 1)
Pin 4 (Ground)
Pin 14 (Port 3 Aux Switch Input 2)

LED (any color)

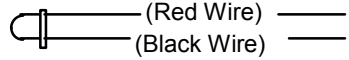

(Red Wire) — Pin 15 (Feedback LED - Relay1 Green Output)
(Black Wire) — Pin 12 (Ground)

Yaw Rate Sensor

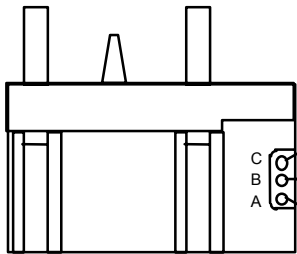

Pin 11 (Port 3 Aux Analog)
Pin 4 (Ground)
Pin 1 (+5 Vdc)

G.7 ROBOT PNEUMATICS

This pneumatics section is intended to give introductory information on how a pneumatics system could be useful in operating various mechanisms on your robot. Teams should be familiar with the **2008 FIRST Pneumatics Manual**,

available for download at <http://www.usfirst.org/>. This document provides comprehensive

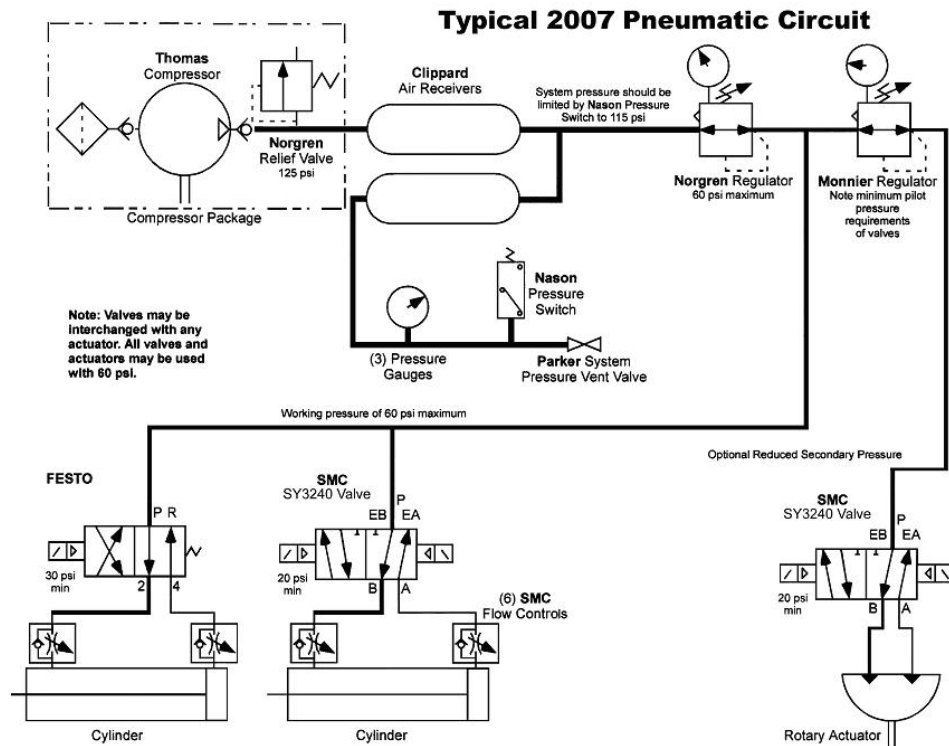

information about installing the pneumatic components. The manual also includes information about the ordering process for additional air cylinders and actuators.

Teams utilizing pneumatics may choose to not use an on-board air compressor but simply charge up the bank of Clippard storage tanks with compressed air for pneumatic functions prior to entering the playing field. When the compressor is not fitted, the on-board pneumatic system must still include the 60-psi regulator, the 60-psi pressure gauge, and relief valve.

The figure below shows a diagram of a typical Pneumatics System that may be configured from pneumatic components supplied in the FIRST KOP. This system converts electrical energy into highly pressurized air (pneumatic energy) via a compressor, which is stored in air volume tanks. Whenever the robot controller programming requires air energy, it is delivered via the high-pressure tubing to a selected solenoid-controlled valve to operate a cylinder to perform work for the robot.

G.7.1 Component Definitions

Thomas Compressor - The compressor operates from the 12Vdc battery and, when turned ON/OFF by the controller signals, will charge the Clippard air volume tanks to 125psi.

Norgren Relief valve - Limits the compressor output to 125psi.

Vibration Isolators - are provided in the kit to shock-mount the compressor, which, during air charging, will vibrate significantly.

Clippard Tanks – Two tanks are provided in the **2008** KOP and may be used to store and provide a steady volume of 125 psi compressed air to downstream regulators and actuators. Up to 4 Clippard volume tanks may be used on the robot for this year's game.

Nason Pressure Switch - Monitors the stored air pressure. The Pressure switch sends signals to the controller to start and stop the compressor to maintain the pressure.

Wika Pressure Gauges – Located on each regulator and on the high-pressure line, **pressure gauges are required to be installed** in your pneumatic system to display the 60psi (working) and the 125psi (storage) pressures. The third gauge showing the secondary regulator “psi” value is not required, but recommended.

Optional Pressure Transducer – Sensor outputs voltage proportional to air pressure to report air pressure status to custom circuitry.

Parker Vent Valve – The Vent valve is a **required safety component** used to bleed all air pressure from the air storage tanks whenever the system is not in use.

Norgren Regulator Valve – The Norgren Regulator valve **is a required component** that must be mounted in line directly after the storage tanks and is adjustable to limit the “working” air pressure of the system to a maximum of 60psi.

Monier Secondary Regulator – The secondary regulator is located after the Norgen 60psi Regulator connection and allows for a lower pressure pneumatic leg if needed.

Solenoid Valves – The solenoid valves electrically control the position of mechanical valves to steer air into the cylinders and drive or retract the cylinders in the desired direction. In the KOP four valves are “single” solenoid operated. When these solenoids are not energized, the solenoid is spring actuated to set the valve rod to retract the cylinder. When the solenoid is operated, the valve rod will be electromagnetically driven to change the airflow port direction. The air will then drive the cylinder into its extended position until the solenoid is de-energized. Then spring pressure resets the valve rod to vent the air and retract the cylinder.

In the figure above, all solenoids are shown in the de-energized state. The arrows indicate the direction of airflow from the P (pressure) line to R (return). When energized, the arrows are shifted to the right and the airflow will now be supplied in reverse direction to the cylinder.

Two SMC “12V Double” solenoids are provided. A “Double” solenoid has a pilot solenoid coil on each end of the spool assembly. By pulsing one coil and/or the other, you can control the air direction and, as a result, the amount of extension or retraction of the cylinder at will. When power is removed, the cylinder remains in a fixed position until the manual overrides are activated to release air pressures.

BEST BET: On a double solenoid, energize only one solenoid at a time!

Air Cylinders & Actuators - The Pneumatic System drawing shows linear air cylinders and a rotary actuator that could be used. You can order up to three more (cylinder/rotary actuator) devices supplied free using the order form in the *FIRST Pneumatic Manual*. Besides free components, you may use additional solenoid valves and air cylinders or rotary actuators. However, they must be identical to those listed on the Pneumatic Components Order form, and obtained from a Bimba or Parker Hannifan distributor.

Flow Control Valves - Above each end of the linear air cylinders, is the graphic symbol for a Flow Control valve. These adjustable valves (mounted on or as close to the cylinder as practical) permit free airflow from a solenoid valve to a cylinder, but control the exhaust airflow rate from the cylinder, thus slowing its mechanical action in returning to the relaxed state.

G.7.2 Pneumatic Electrical Distribution

The figure below shows a simple electrical connection diagram of the power, sense, and PWM control wiring of the pneumatic actuator components. In reality, more pneumatic components may be used in your system, but they will essentially conform to the connections as depicted below and according to the electrical distribution drawing included at the end of this section.

Tips on Assembly

Air Compressor - Be sure the air compressor receives 12Vdc power from its own spike relay. We recommend the spike relay be operated from a 20-amp Snap-Action circuit breaker.

Nason Pressure switch - The Nason Pressure switch must be wired via a PWM type cable directly back to the robot controller digital input port. The robot controller, when programmed, controls the ON/OFF switching of the compressor spike relay.

Do not wire the pressure switch in series with the compressor power lines. Even if the relay could be operated this way, the switch cannot handle the starting current of the compressor.

Teflon Tape & Fittings- all threads on male fittings require Teflon tape to seal properly. Start by wrapping the tape around the fitting leaving the first two threads bare and in the direction of the threads. This is because the fittings are tapered, and should the tape become loose at assembly, it will not block the valve opening.

Tubing – One thing will become apparent. Tubing that is too short will likely make an unreliable connection. Allow for flexible bends in the tubing as necessary.

Cut tubing with clean perpendicular cuts. Slide tubing fully into the Quick Connect fittings. Press down on the release ring to remove the tubing if necessary.

Cylinder – Assure the load on the cylinder is connected before operating the device.

Leaks – Once the pneumatic connections and electrical interconnections have been made, the system should be tested for charging air to the pressure values assigned by the Rules for the primary and secondary legs of the system. Close the Norgren Relief valve. Run the Thomas

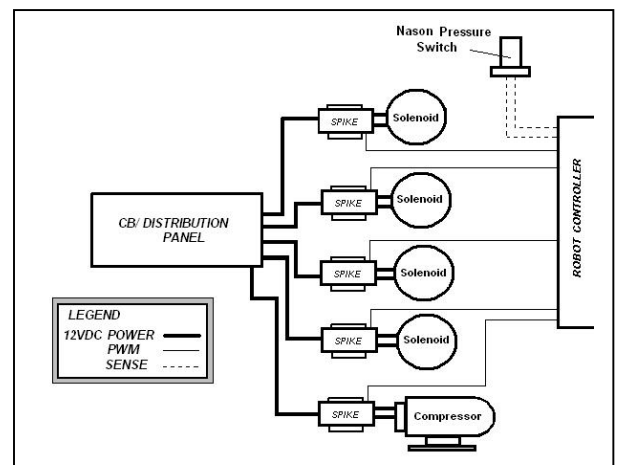

compressor to the 125-psi pressure. At 125 psi the compressor should shut down. The regulators should then be adjusted as necessary to the 125 psi and 60 psi values permitted.

The system pressure should remain intact until a solenoid has been activated. If the pressure is deteriorating without any solenoid operations, the system must be checked for leaks and the faulty coupling repaired, usually by fixing the Teflon tape seal. Open the Norgren relief valve and confirm the system pressure decays to 0 psi before disconnecting any couplings to effect repairs.

When the system pressure test is completed, release any stored air pressure by opening the Norgren relief valve, observing the system pressure decays to 0 psi.

G.7.3 The Flag Holder

Each robot is required to have a flag holder installed on the robot to hold and display the alliance pennant color during the match. The flag holder must be mounted such that it complies with the rules in the manual.

The red and blue bicycle flags are approximately 36" in length on a 1/4" fiberglass pole.

G.7.4 One Last Look

This paragraph is intended to have the team focus on the Game Rules that apply to the anticipated interactive contact in the competitions and to take a last look at their robot. The rules are very specific on the type of strategies that will not be allowed.

One area to check and address now is if your robot has by its design loose cables, hoses, cordage, netting or fabric, etc. that can be entangled or could entangle with other robots in a competition. Robots, so designed, become subject to disqualification in a match and will require repairs before continuing in the competition.

Also recall that arms or mechanisms that protrude from the robot such as forklifts, lifting arms, grappers, etc. must not pose as a hazard for team members or event staff in that they can impale or puncture personnel or field equipment. No Wedge-type front ends allowed.

Verify that the robot has the Team Number visible in all four directions and in the letter size as specified in the Rules and that the School name and Primary sponsor's name are also displayed prominently on the robot.

